

A WORK OF ART. POWERED BY AIR.®



**pneumatic**  
*vacuum elevators*

THE COMPANY

PVE - PNEUMATIC VACUUM ELEVATORS

# BIG IDEAS REVOLUTIONIZE THE WORLD



# FOUNDED IN 2002

Pneumatic Vacuum Elevators, LLC (PVE) is the inventor and sole manufacturer of the world's only Air-Driven Home Elevator, the Pneumatic Elevator.

Powered by the most abundant resource in the world, AIR, Pneumatic Elevators are innovative, space-saving home lift solutions that have revolutionized the way people and goods are transported vertically inside their homes.

Using Pneumatic Technology® to generate lift, these self-supporting, panoramic elevators smoothly move between floors while requiring much less space, energy & maintenance when compared to traditional elevators.

With three models to choose from, ranging from a single passenger to a three passenger wheelchair-accessible model, Pneumatic Elevators simply rest on the existing ground floor, offering an ease of installation while providing an aesthetically pleasing solution for both retro-fit & new construction projects.

Manufactured in Miami, Florida, USA, PVE is an innovative, technology driven company that thinks outside of the box, having our customers always in mind and our engineering capabilities second to none.

Utilizing materials and components of the highest quality available, Pneumatic Elevators unique design is based around our patented technology and PVE is proud to manufacture fully certified, safe and reliable home elevators for use worldwide.

With manufacturing facilities in Argentina, Spain and India, PVE has over 20,000 successful installations worldwide in over 100 countries. Partnered with authorized distributors across the globe, PVE ensures all end users the best quality of installation and service for their home elevators.

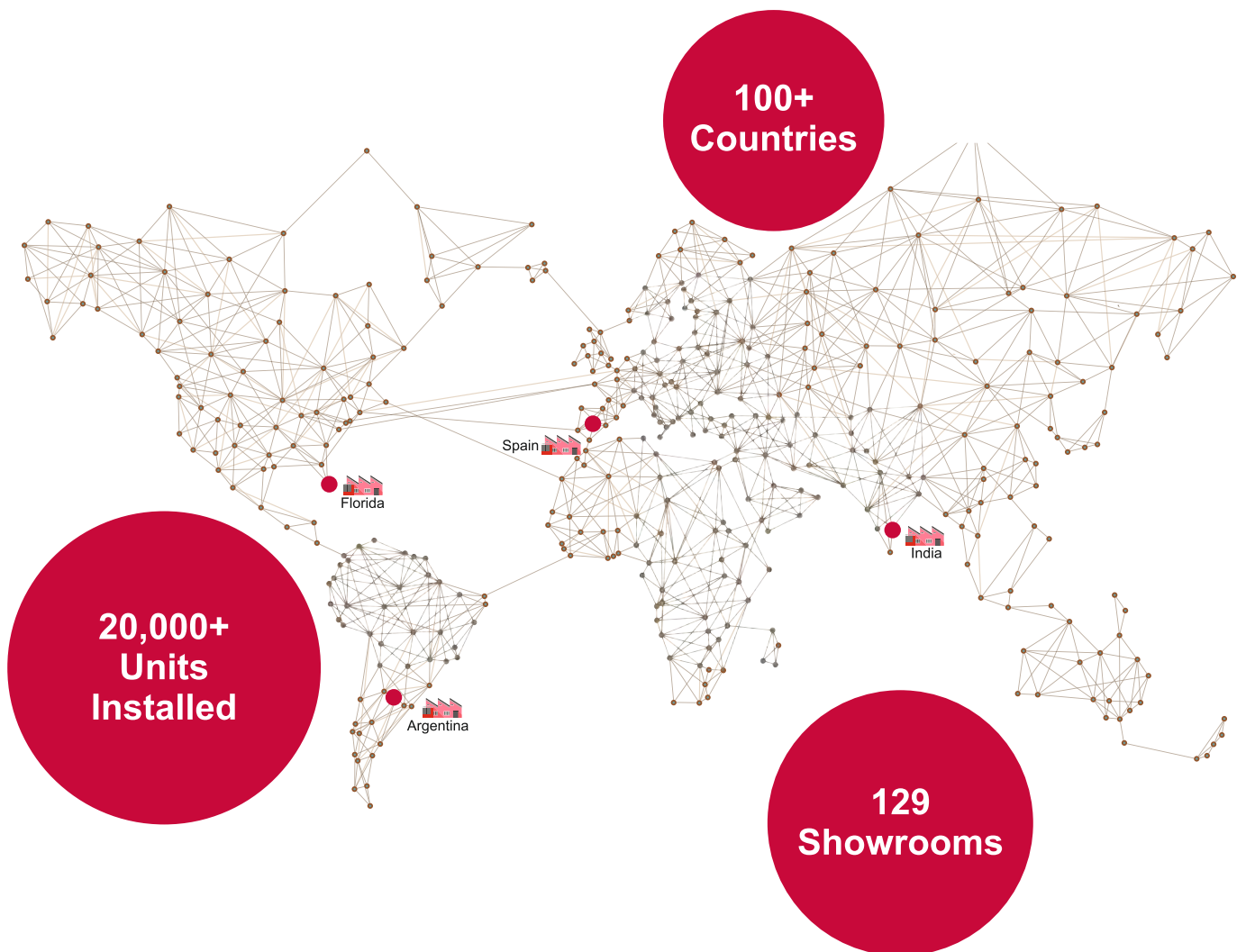

# INNOVATIVE SOLUTION

By using Pneumatic Technology® to generate areas of higher and lower pressure within the cylinder hoistway, Pneumatic Elevators combine a vertical cylinder with a fully enclosed car that smoothly moves up and down through air suction and gravity.

## What advantages do Pneumatic Elevators offer?

Not requiring a pre-construction shaft, pit or machine room, Pneumatic Elevators simply rest on the existing ground floor, offering more flexibility of installation while optimizing space within the home.

With minimal pre-construction requirements, Pneumatic Elevators are quick & easy to install with installations being completed in as little as 2 - 3 days.

A plug & play system requiring a 220 volt power supply, these eco-friendly elevators utilize very few moving parts during operation and have minimal maintenance requirements with no harmful oils, gases or lubricants utilized for operation.

Certified for up to 5 stops or 50 feet in total rise, Pneumatic Elevators are custom built to the height of each home with three different sizes available to meet your projects spatial and installation requirements.



**System of Operation For The Pneumatic Elevator**

1. During ascent, the system extracts air from the top, creating a vacuum that makes the elevator car go upwards.

2. For descent, the intake of air is controlled, causing the car to smoothly move downwards due to gravity.

*Pneumatic Technology® simplifies the operation while reducing wear and tear of components: a smooth, safe & reliable system.*



**Components**

There are three main components to the transparent, self-supporting Pneumatic Elevator:

**Exterior Cylinder** - Made up of an aluminum frame and polycarbonate panels that offers panoramic visibility.

**Elevator Car** - Fully welded and enclosed cabin made of steel, which houses the brake and safety mechanisms along with the proprietary seal located on top of the car.

**PVE Machinery** - Installed on top of the upper floor cylinder or remotely located. Houses the turbine motors, valves and PVE controller used to operate the elevator.

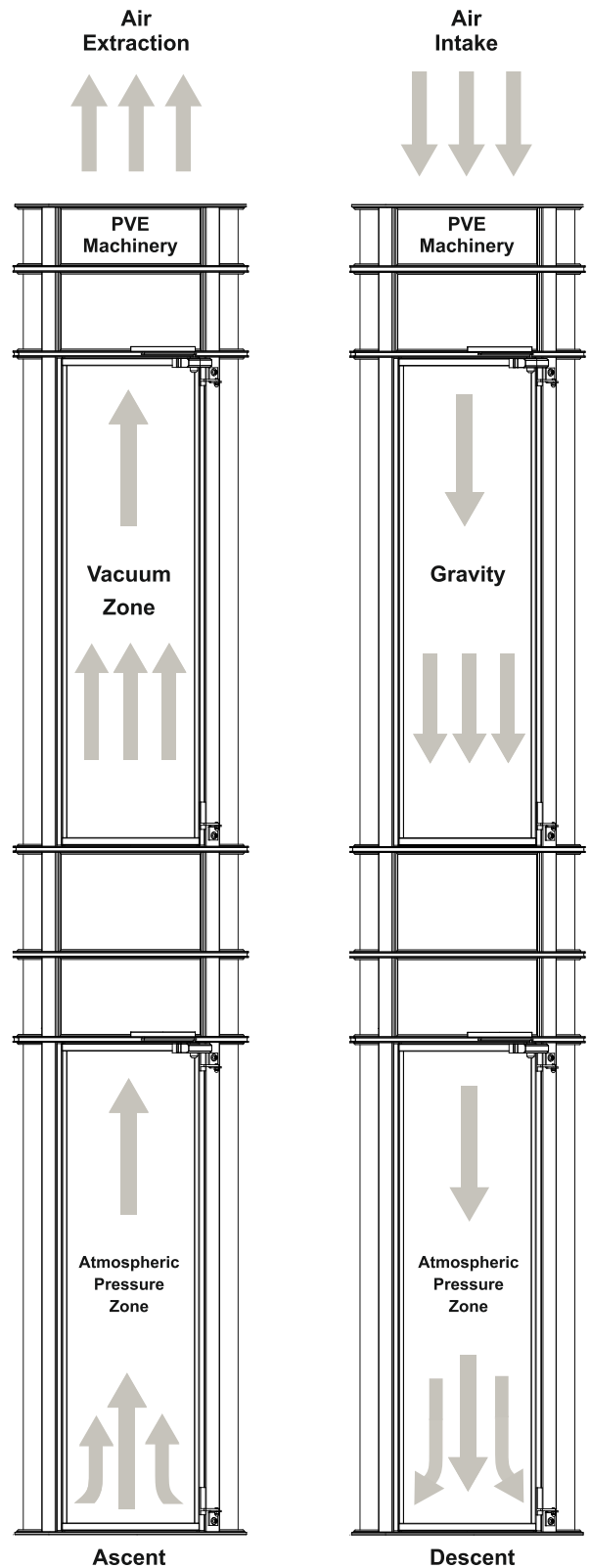



Model: PVE52  
Customization: Custom Left Hand Doors  
Color: White



# ELEGANT DESIGN

At PVE, our mission is to create home elevator solutions in which design and technology coincide. Where the utilization of attractive materials and the application of fundamental physics combine to produce an innovative & aesthetically pleasing elevator that enhances homeowner's standard of living.

The result : **Pneumatic Elevators.**

With its minimal footprint, modern design & revolutionary technology, these eco-friendly elevators go where other home elevators simply cannot.

A versatile solution that fits into even the tightest of spaces, all three Pneumatic Elevator models are self-supporting with minimal pre-construction requirements allowing a faster & more flexible installation.

Utilizing a unique, circular design, these panoramic elevators offer 360° degree visibility while traveling up to 5 stops or 50 feet in total rise making them beautiful additions to any residence.

"Green Elevators" that operate using Pneumatic Technology®, minimal energy consumption is utilized during ascent and gravity is simply used for descent ensuring Pneumatic Elevators have a nominal impact to your annual electrical usage.

ADVANTAGES



Model: PVE30  
Color: Anodized Silver

## ABSOLUTE SAFETY

Pneumatic Elevators are annually certified & safety inspected by the prestigious Liftinstituut, one of the world's leading elevator certification organizations.

In the event of power failure while in operation, the Elevator Car will automatically descend to the lowest level and the mechanical door lock opens to allow passengers to safely exit.



ADVANTAGES

# REMAIN IN THE COMFORTS OF YOUR HOME



# 3 MODELS AVAILABLE

With 3 Models Available, There Is A Pneumatic Elevator To Fit Any Projects Needs.



## PVE 30

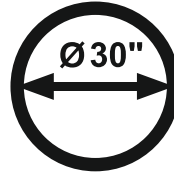

### Single Passenger Elevator

**30 Inches (750 mm) External Diameter**

Lift Capacity (159 kg)

**Traveling Speed 0.15 m/s**

Automatic Interior LED Lighting & Fan

In-Line Door Openings



## PVE 37

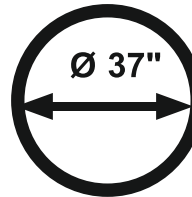

### Two Passenger Elevator

**37 Inches (950 mm) External Diameter**

Lift Capacity (205 kg)

**Traveling Speed 0.15 m/s**

Automatic Interior LED Lighting & Fan

In-Line, Walk-Through & 90° Door Openings\*

\*Limitations With 90° Door Openings



## PVE 52

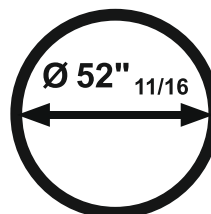

or



### Three Passenger Elevator Wheelchair Accessible

**52 11/16 Inches (1,338 mm) External Diameter**

Lift Capacity (238 kg)

**Traveling Speed 0.10 m/s**

Automatic Interior LED Lighting & Fan

In-Line & Walk-Through Door Openings

# PVE MODEL SPECIFICATIONS

Technical Specifications For All 3 Pneumatic Elevator Models.



## General

	pve 30	pve 37	pve 52
Maximum Load (Kgs)	159	205	238
Speed	30 fpm (0.15m/s)	30 fpm (0.15m/s)	20 fpm (0.10m/s)
Number of Stops	2 to 5	2 to 5	2 to 5
Maximum Distance (Feet)	50	50	50

## Car

Inside Diameter - Widest Point (Inches)	25"	32" 1/2	46" 3/4
Doorway Width (Inches)	20"	20" 1/2	32"
One-Touch Operation	Yes	Yes	Yes
Wheelchair Accessible	No	No	Yes

## Door

Available Entrances **	0°	0°, 90°, 180° and 270°	0° and 180°
Possibility of an Automatic Door	Yes	Yes	Yes

## Safety

Power Failure Automatic Descent	Yes	Yes	Yes
Alarm Button / Safety Telephone	Yes	Yes	Yes

## Electricity

Supply	220 V/20 A	220 V/26 A	220 V/32 A
Power	3.3 kW	5.5 kW	6.6 kW

## Installation Requirements

Finished Perforation Diameter (Inches)	32"	39"	54" 11/16
Minimum Height on Upper Floor (Inches) *	107" (8 ft. 10 inch)	107" (8 ft. 10 inch)	107" (8 ft. 10 inch)

\* Lower Height Clearances are possible. Speak to a PVE Sales Representative to confirm the feasibility of your desired installation.

\*\* Door Configuration Options available for review on Page 18.

PVE 30

# PVE30



Rated Load  
(159 kg)

Model: PVE30  
Color: Anodized Silver



PVE37

# PVE37



Rated Load  
(205 kg)

Model: PVE37  
Upgrade: Cabin Folding Seat  
Color: White



PVE52

# PVE52

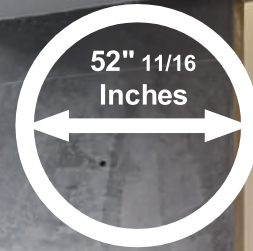

Rated Load  
(238 kg)

Model: PVE52  
Color: Anodized Silver



PVE | 12

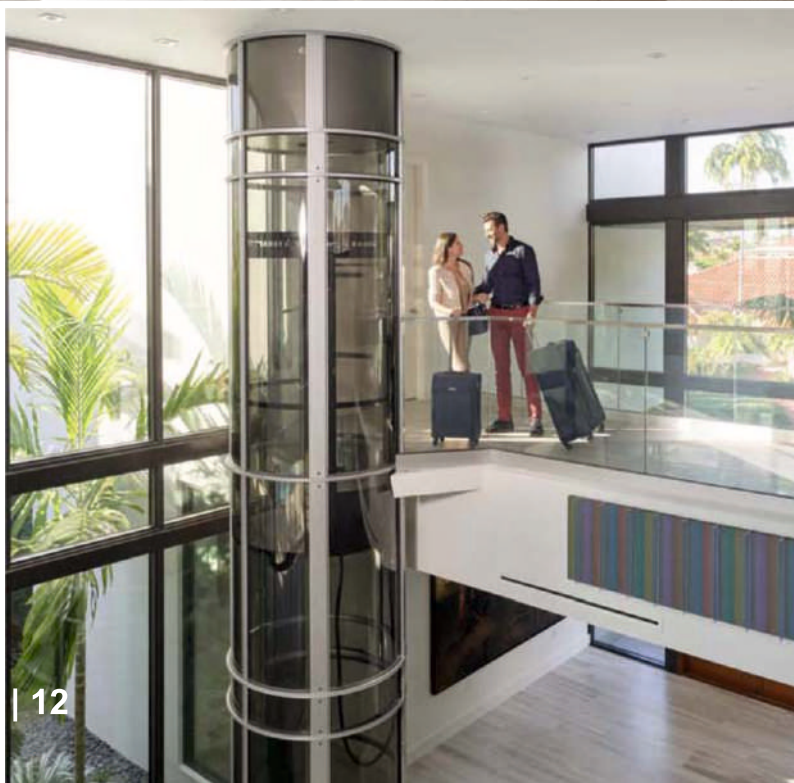

# Special Applications

Intended As A Residential Elevator, There Are A Few Unique Applications Where The Elegance Of The Pneumatic Elevator Can Shine Through.

## Stage Elevator



*It is recommended to speak to a local authorized PVE distributor to discuss local codes and regulations prior to considering the Pneumatic Elevator for any Stage Applications.*

## Yacht & Marine Elevator

Easy-To-Install, Space-Saving Elevators for Yacht & Marine Applications.



*With its minimal footprint, ease of installation and plug & play features, Pneumatic Elevators are the ideal elevator solutions for any Yacht & Marine Applications.*

*With no pre-construction pit, hoist-way or machine room required, each Pneumatic Elevator is custom built to the height of the vessel while adding an elegant design feature that will capture people's attention & imagination.*

# PVE MACHINERY CONFIGURATIONS

Depending On The Available Height In Your Home,  
There Are Different PVE Machinery Configurations Available For Your Pneumatic Elevator.

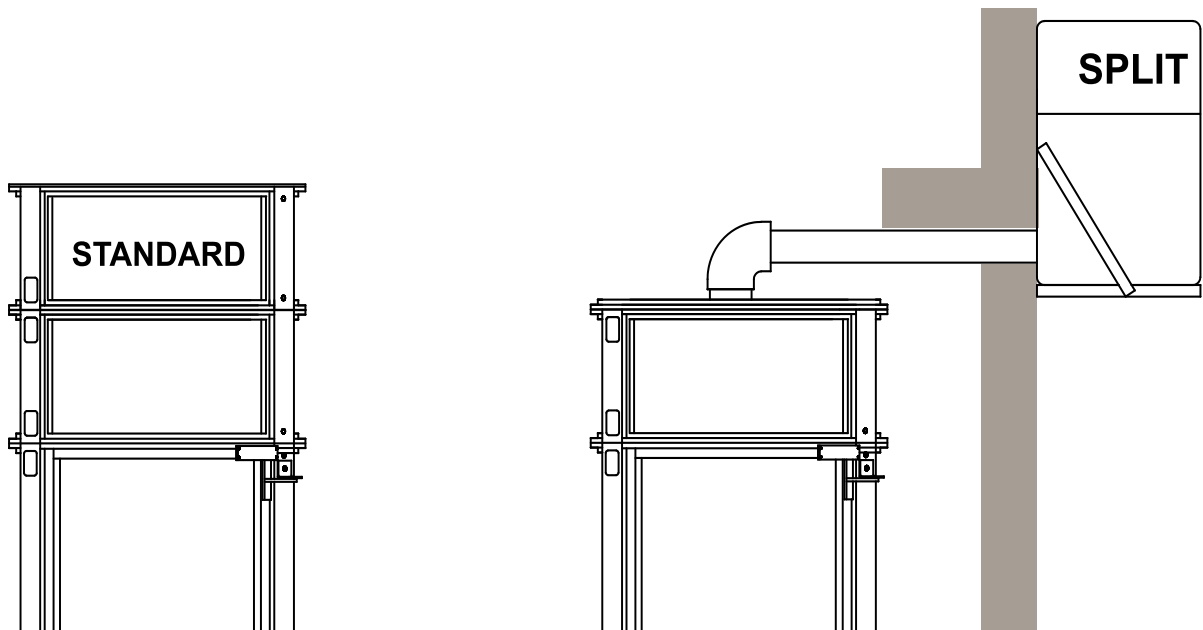

## STANDARD MOUNT CONFIGURATION

A quick to install, aesthetically pleasing solution, Standard Mounted applications allow for the PVE Machinery to be installed directed on top of the upper-floor cylinder.

The simplest solution in terms of installation, Standard Mounted applications are plug & play systems that require a 220 volt power supply to be located directly above or close to the top of the unit.

### MINIMUM HEIGHT ON THE UPPER FLOOR

2700 mm \*

\* Lower Height Clearances are possible.  
Speak to a PVE Sales Representative to confirm the feasibility of your desired installation.

## SPLIT-UNIT MOUNT CONFIGURATION

Designed to accommodate installations with lower overhead clearances, Split-Unit Mounted applications allow for the PVE Machinery to be remotely located from the top of the unit.

With both Indoor and Outdoor Split-Unit options, remotely locating the machinery reduces the minimum height required on the top floor with the PVE Machinery installed up to 30 linear feet away from the top of the upper-floor cylinder.

Connected to the top of the elevator by two 4" inch PVC pipes or a flex hose alternative, Split-Unit Mounted applications requires a 220 volt power supply to be located wherever the PVE Controller is installed.

### MINIMUM HEIGHT ON THE UPPER FLOOR

2700 mm\*



# STANDARD MOUNT

PVE Machinery Installed Directly Above The Unit.

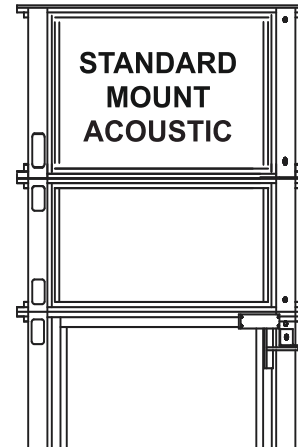
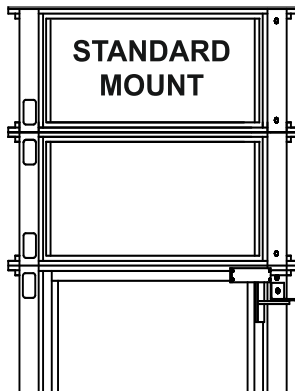

## STANDARD MOUNT

Included as the base PVE Machinery option for all Pneumatic Elevator orders, a Standard Mount application allows for the PVE Machinery to be installed directly on top of the upper floor cylinder.

### ADVANTAGES

*Standard Mounted Machinery.*

*Quick & Easy Installation.*

*Self-Contained, Plug & Play Operation.*

### MINIMUM HEIGHT ON UPPER FLOOR

**2700 mm \***

## STANDARD MOUNT ACOUSTIC

Utilizing audio engineering and sound proofing material to reduce decibel ratings, the Standard Mount Acoustic upgrade option allows for the PVE Machinery to be installed directly on top of the upper floor cylinder.

### ADVANTAGES

*Decibel Reducing Solution for Standard Mounted Applications.*

*Plug & Play System.*

*Easy-to-Install Machinery Option.*

### MINIMUM HEIGHT ON UPPER FLOOR

**2700 mm \***

\* Lower Height Clearances are possible.

Speak to a PVE Sales Representative to confirm the feasibility of your desired installation

# SPLIT-UNIT MOUNT

PVE Machinery Remotely Located Up To 30 Linear Feet Away From The Top Of The Unit.

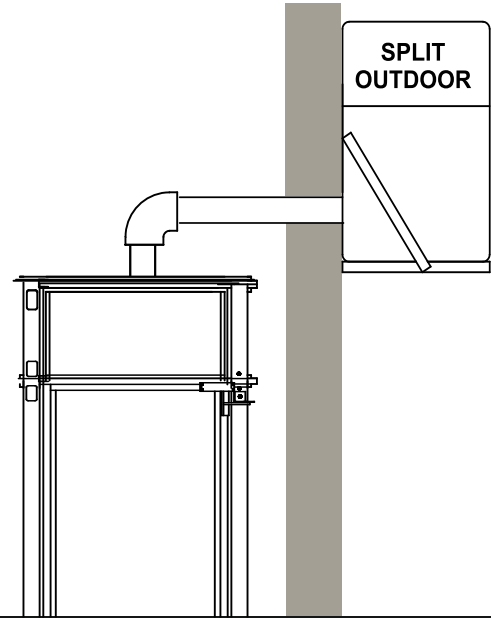
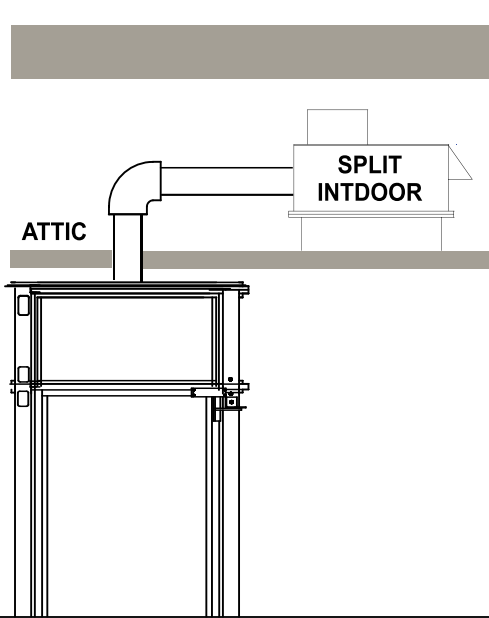

## SPLIT-UNIT MOUNT INDOOR

*Designed to accommodate installations with lower Overhead Clearances on the top floor, the Split-Unit Mount - Indoor machinery option is an upgrade that allows the PVE Machinery to be installed remotely inside the home.*

*Connected to the top of the elevator by two 4" inch PVC pipes or a flex hose alternative, the Split-Unit machinery can be installed up to 30 linear feet away from the top of the unit and is often located in attics, adjacent closets or mechanical rooms within the home.*

### ADVANTAGES

*Lower Overhead Clearance Requirements on the Top Floor.*

*Reduction of Decibel Ratings Inside Home.*

*Customizable Positioning of the Split-Unit Machinery Inside the Home.*

### MINIMUM HEIGHT ON UPPER FLOOR

2700 mm \*

## SPLIT-UNIT MOUNT OUTDOOR

*Designed to allow the PVE Machinery to be installed externally from the home, the Split-Unit Mount - Outdoor machinery option is an upgrade designed to allow the PVE Machinery to be installed in an exterior setting.*

*Installed inside a fiber glass enclosure, this PVE Machinery solution is connected to the top of the elevator by two 4" inch PVC pipes or a flex hose alternative and can be installed outside up to 30 linear feet away from the top of the unit.*

### ADVANTAGES

*Lower Floor-to-Ceiling Height Requirement on the Top Floor.*

*Most Efficient Audio Solution for PVE Machinery.*

*Customizable Positioning of the Split-Unit Machinery Outside the Home.*

### MINIMUM HEIGHT ON UPPER FLOOR

2700 mm \*



Model: PVE37  
Upgrades: Split-Unit Mount  
Color: Standard Gray

# PVE INSTALL

BALCONY WITH LANDING

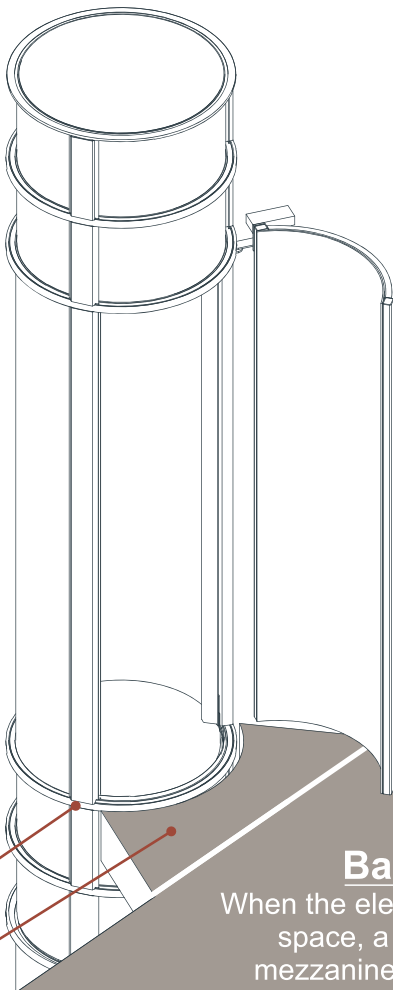

Balcony Band

Balcony Landing

EMBEDDED BALCONY

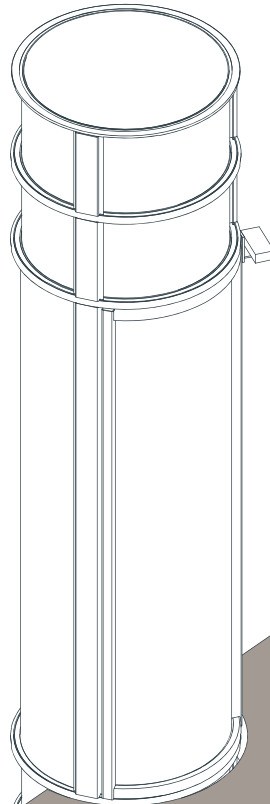

THROUGH-FLOOR

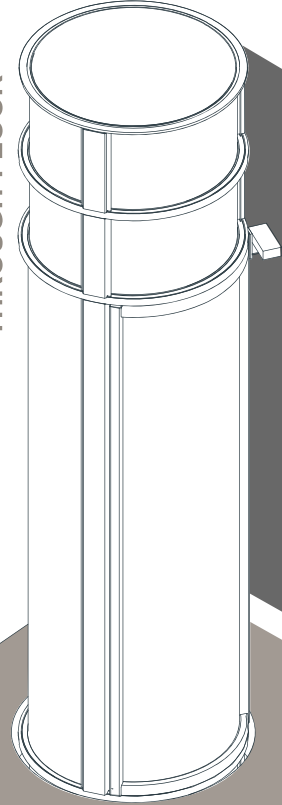

## Balcony Applications

When the elevator is installed in an open space, a double-height area, in-door mezzanine or a stairwell where it's not applicable to have a through-floor hole.

For Balcony Applications, it's necessary to install a **Landing, Platform or Walkway** (not provided) at the balcony level for ease of entry & exit for the passenger.

Given the elevators circular design, this pre-construction requirement covers the space between the elevator and balcony floor while ensuring stability as the Pneumatic Elevator is attached to the structure on each level by means of a Balcony Band (provided by the installer).

## Types of Landings

Different Configurations for a Walkway or Platform



# APPLICATIONS

## Through-Floor Applications

A finished through-floor hole is made at each level with a finished diameter 2" inches greater than the exterior diameter of the Pneumatic Elevator model. In applications with three, four or five stops, the holes must be perfectly aligned.

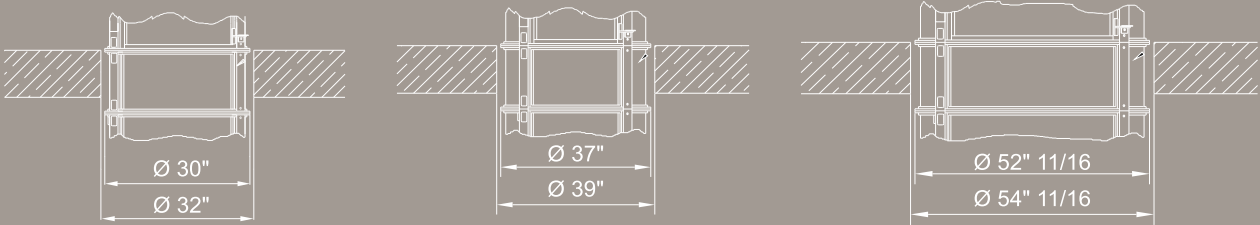

*Minimum diameters for finished holes in through-floor installations*

## Balcony Landings

For a Landing, Platform or Walkway constructed for Balcony Applications, it is recommended that the finished landing at its widest point be 1/2 inch greater than the diameter of the Pneumatic Elevator purchased. Meeting this recommendation will ensure that the Pneumatic Elevator chosen will fit properly, with a clean aesthetic.

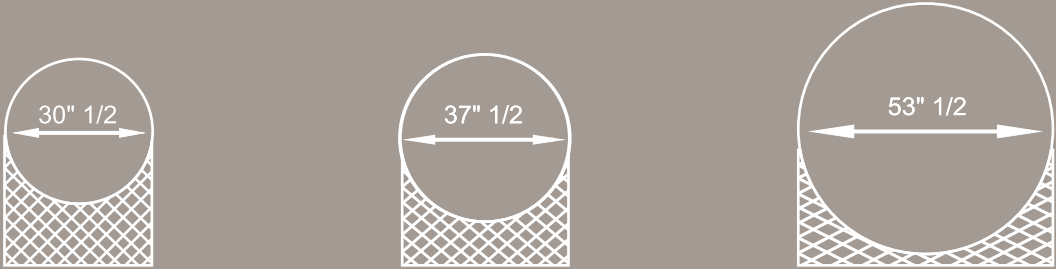

# OPTIONS & UPGRADES

Enhance Your Pneumatic Elevator With These Options & Upgrades Available For All 3 Models.

## COLOR OPTIONS

Powder Coated Color Finishes Available For The Exterior Aluminum Frame Of The Elevator:

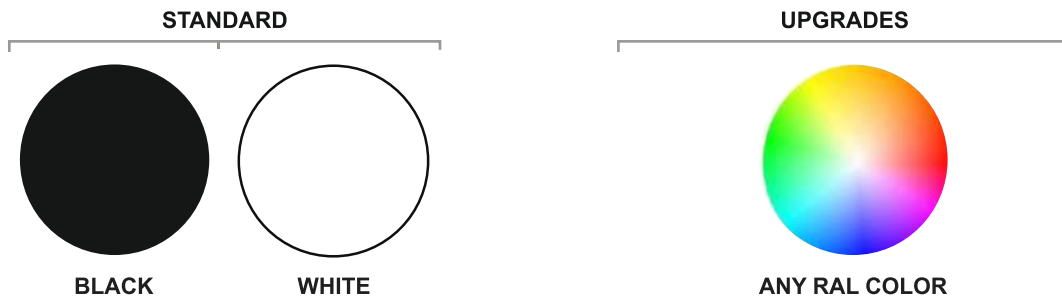

## In-Cabin Upgrades

Upgrades Available For The Interior Cabin Of The Pneumatic Elevator:

CABIN TELEPHONE



CABIN KEY LOCK



## ELEVATOR UPGRADES

Enhance Your Pneumatic Elevator By Including Our Latest Upgrades:

### SMART HOME INTEGRATION

*Integrate your Pneumatic Elevator with Smart Home Devices like Amazon Alexa or Google Home to operate your elevator using voice commands and/or smart phones.*

### TOP FLOOR EXTENSION

*Extend the top of your elevator to terminate 1" inch below the ceiling for a clean aesthetic & finish.*

### BATTERY BACK-UP PACKAGE

*Battery Back-Up Package ensures your Pneumatic Elevator is operable even if the electricity goes out inside your home*

### EARTH QUAKE BRACKETS

*Often installed in seismic zones, Earthquake Brackets allow the Pneumatic Elevator to be bolted to the ground floor.*

### REMOTE CONTROL

*Command your Pneumatic Elevator in the palm of your hand with a single click by including our Remote Control, Programmable up to 5 Stops.*

### HOMING FEATURE

*Program the cabin for your Pneumatic Elevator to automatically travel to a designated floor after a specific period of time to ensure your cabin always rests at a pre-programmed floor after use.*

# PVE37 MODEL UPGRADES

Options & Upgrades Available For The 2-Passenger, PVE37 Pneumatic Elevator:



## Cabin Folding Seat

**Cabin Folding Seat option offers the ability for a folding seat and a handle to be installed inside the cabin.**  
(Available only for the PVE37 model.)

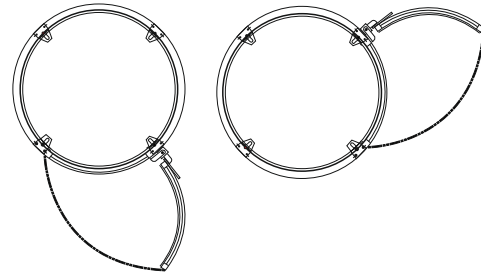

## 90° Degree Door Configurations

**90° Degree Door Configuration allows for the upper floor doors to be directed 90° degrees to the left or 90° degrees to the right from the ground floor door.**  
(All upper floor doors must be same side as one another.)

# PVE CUSTOMISATIONS

Available For All 3 Models, These PVE Customizations Require An Extended Production Time To Manufacture:



## Custom Tinted Polycarbonate Panels

*Custom Tinted Polycarbonate Panels offers a Bronze Tinted finish to your Pneumatic Elevator.*



## Custom Left Hand Door Swing

*Custom Left Hand Door Swing allows the door to be hinged on the top Left Corner when facing the Pneumatic Elevator from outside. See drawing above for reference. (All Floors Will Have Same Door Swing On All Levels)\**



## Automatic Door Opener / Closer

*Automatic Door Opener/Closer allows the door for your Pneumatic Elevator to be programmed to automatically open & close upon arrival.*

*\* Custom Door Configurations/Swings may be feasible depending on layout, model & project requirements. Speak to a PVE Sales Representative to confirm the feasibility of your desired installation.*

# Door Configurations

Door Configurations Available For Specific Pneumatic Elevator Models:

Door Openings Configuration		PVE 30	PVE 37	PVE 52
Ground Floor	Upper Floor(s)			
- In Line 0°				
- Opposite 180°	 <i>Possibility of alternating orientation between floors</i>			
- 90° Right	 <i>All Upper floor doors must be same side as one another</i>			
- 90° Left				
		Not Available	Available	

**Door Configurations Shown Above are For Standard Right Hand Door Swings.  
Only One Door Opening Available Per Floor/Level.  
Speak with a PVE Sales Representative regarding Custom Left Hand Door Configurations.**

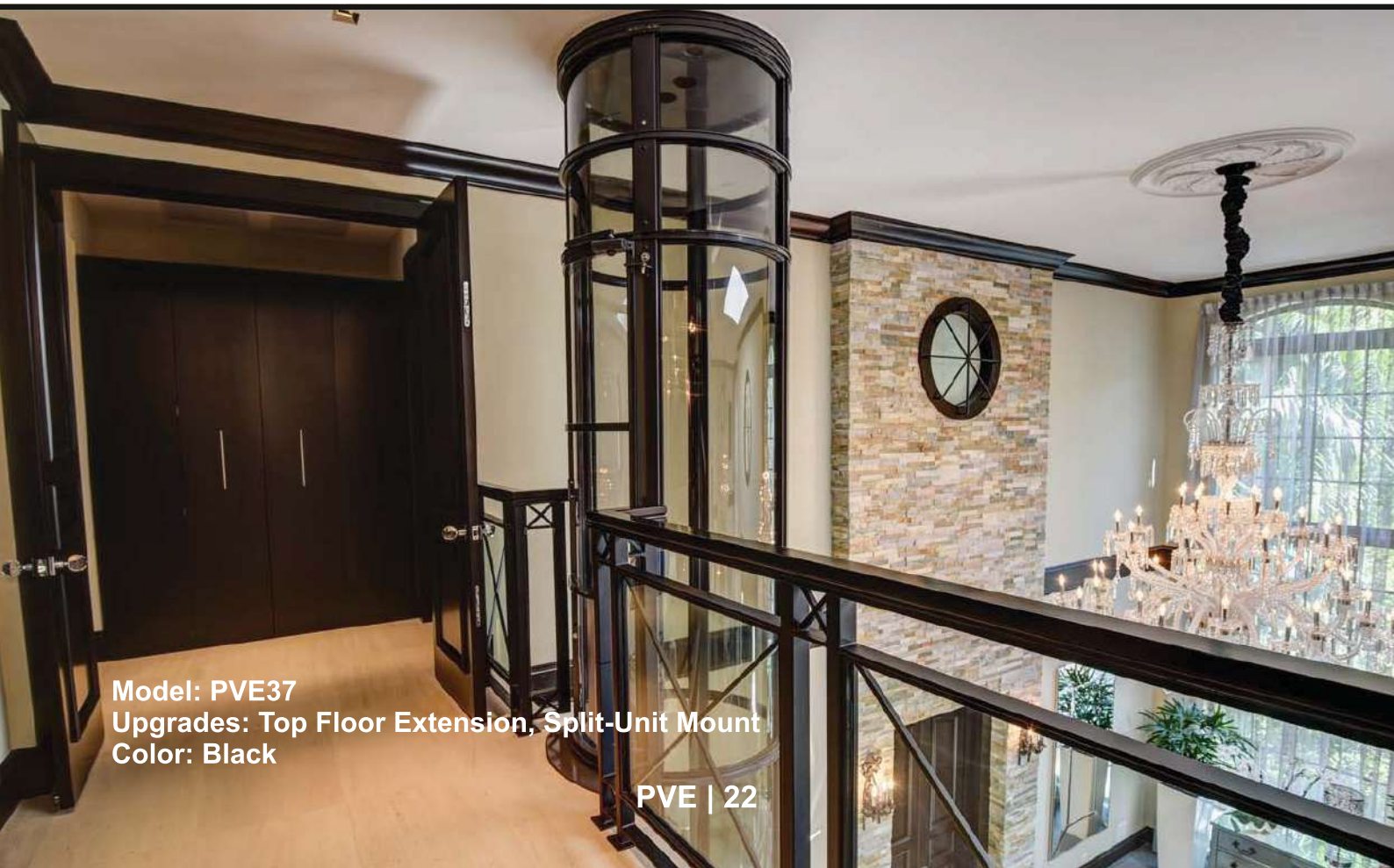

Model: PVE37  
Upgrades: Top Floor Extension, Split-Unit Mount  
Color: Black





# A STANDARD PVE37 CABIN

Car Lock Solenoid

Magnetic Sensor

LED Light

Fan

Telephone

Call Buttons: G,1,2

Alarm

Emergency Stop

Key Switch

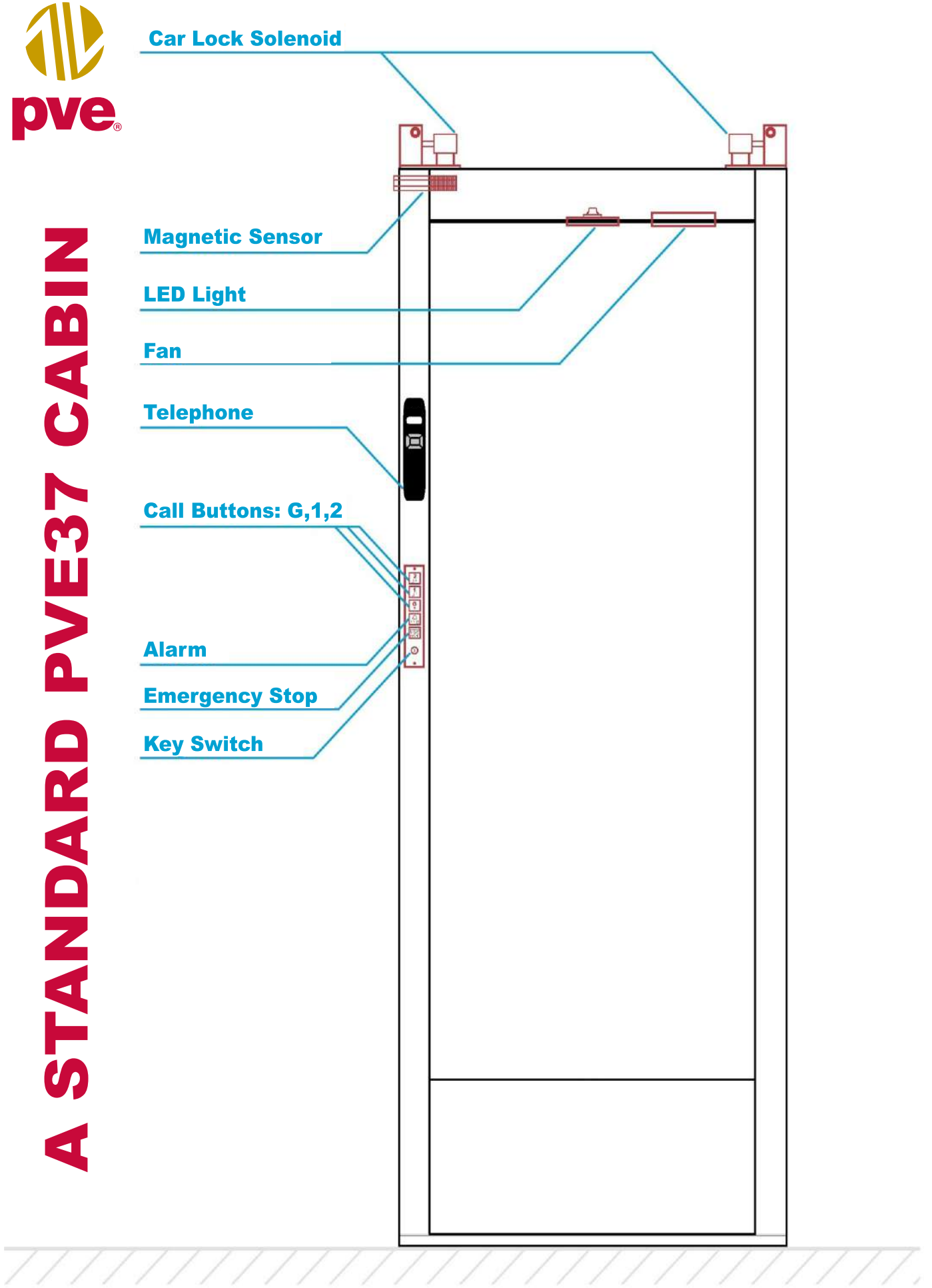



**pve**<sup>®</sup>

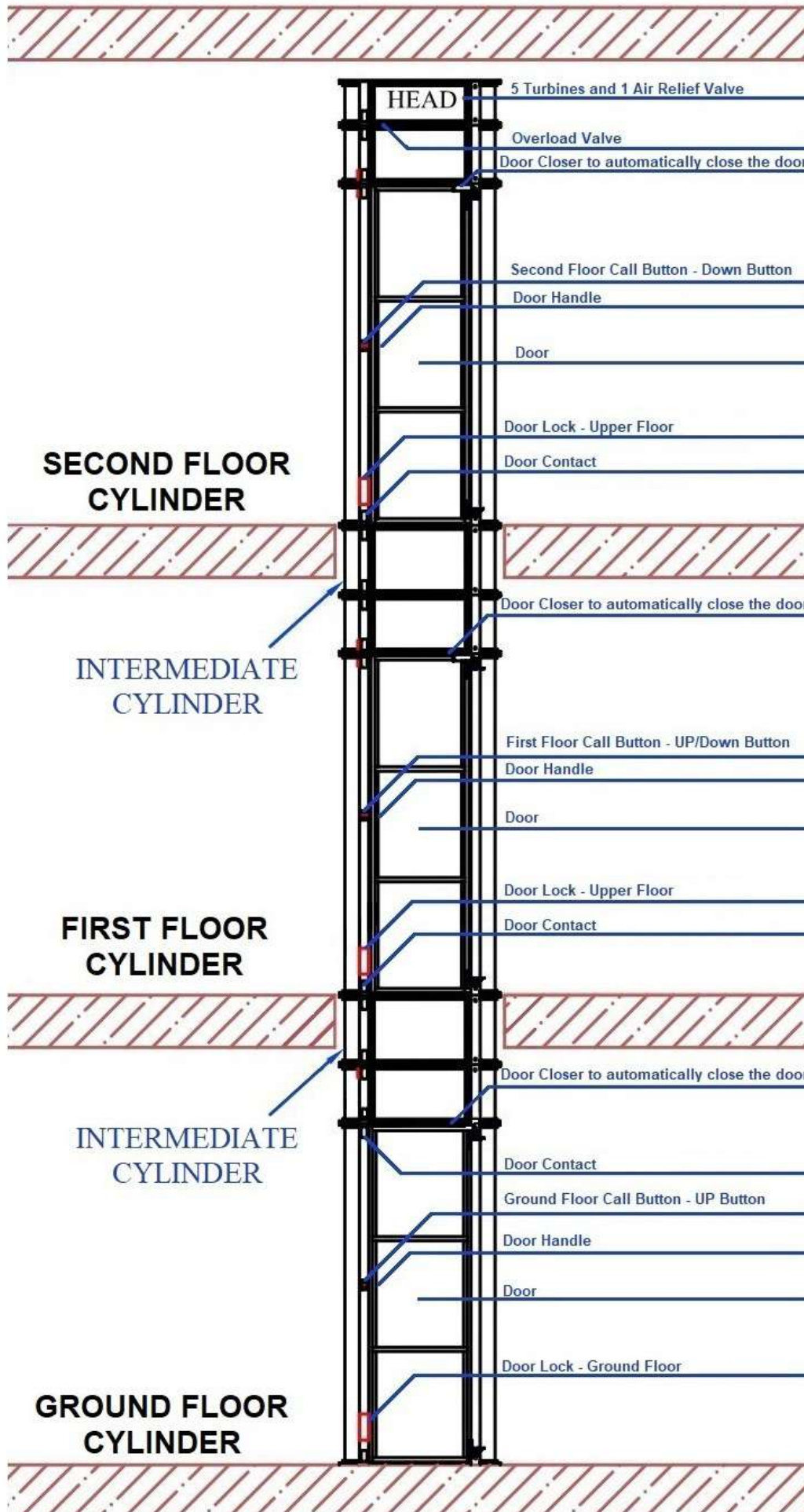

**A STANDARD PVE37 3-STOP UNIT**

# Notes

## Elevate Your Standard of Living



360° panoramic



Unique design



Customizable finishes



Pitless installation



Vacuum lifts



Quick installation (2-3 days)



Eco-friendly product



Maximum safety



Minimal Maintenance



Plug&Play Voltage at 220v



THE ELEVATOR INDUSTRY AWARDS

### WINNER

PRESENTED BY ELEVATOR WORLD, INC.

**PNEUMATIC VACUUM ELEVATORS**

BEST SUPPLIER - COMPLETE ELEVATOR/ESCALATOR SYSTEMS

2018 - WINNER

2019 - WINNER

2020 - RUNNER UP



**pve**<sup>®</sup>  
**pneumatic**  
*vacuum elevators*

**PNEUMATIC VACUUM ELEVATORS AND LIFTS INDIA PVT. LTD.**

Ward No.1/8, Nellikuppam Road,  
Vishnupriya Nagar, Karanai Puducherry,  
Guduvancherry – 603202

(A fully owned subsidiary of the parent company PNEUMATIC VACUUM ELEVATORS LLC, Florida U.S.A.).

[www.vacuumelevatorsindia.com](http://www.vacuumelevatorsindia.com)

**Ph : 044-27438737 / 7550398777 / 333**